

**OPERATOR'S MANUAL  
FRYMASTER BIRE14/MRE14 SERIES  
ELECTRIC FRYER**



This equipment chapter is to be installed in the Fryer Section of the *Equipment Manual*.

**FOR YOUR SAFETY**  
Do Not Store or use gasoline or other flammable vapors and liquids in the vicinity of this or any other appliance.

**MANUFACTURED  
BY**



**8700 LINE AVE.  
SHREVEPORT, LOUISIANA 71106-6800  
PHONE: 1-318-865-1711  
TOLL FREE: 1-800-551-8633  
1-800-24 FRYER  
FAX: 1-318-219-7135**



**TABLE OF CONTENTS**

WARRANTY STATEMENT .....	Page i
INTRODUCTION.....	Page 1-1
INSTALLATION INSTRUCTIONS .....	Page 2-1
OPERATING INSTRUCTIONS.....	Page 3-1
OPERATING THE BUILT-IN FILTRATION SYSTEM.....	Page 4-1
PREVENTIVE MAINTENANCE .....	Page 5-1
OPERATOR TROUBLESHOOTING.....	Page 6-1

Frymaster L.L.C., 8700 Line Avenue 71106, Shreveport, LA 71106  
PHONE 318-865-1711 FAX 318-219-7135

PRINTED IN THE UNITED STATES

SERVICE HOTLINE 1-800-24-FRYER

NOVEMBER 2011

\* 8196151A \*

**NOTICE**

IF, DURING THE WARRANTY PERIOD, THE CUSTOMER USES A PART FOR THIS MANITOWOC FOOD SERVICE EQUIPMENT OTHER THAN AN **UNMODIFIED** NEW OR RECYCLED PART PURCHASED DIRECTLY FROM FRYMASTER DEAN, OR ANY OF ITS AUTHORIZED SERVICERS, AND/OR THE PART BEING USED IS MODIFIED FROM ITS ORIGINAL CONFIGURATION, THIS WARRANTY WILL BE VOID. FURTHER, FRYMASTER DEAN AND ITS AFFILIATES WILL NOT BE LIABLE FOR ANY CLAIMS, DAMAGES OR EXPENSES INCURRED BY THE CUSTOMER WHICH ARISE DIRECTLY OR INDIRECTLY, IN WHOLE OR IN PART, DUE TO THE INSTALLATION OF ANY MODIFIED PART AND/OR PART RECEIVED FROM AN UNAUTHORIZED SERVICER.

**NOTICE**

This appliance is intended for professional use only and is to be operated by qualified personnel only. A Frymaster Dean Factory Authorized Servicer (FAS) or other qualified professional should perform installation, maintenance, and repairs. Installation, maintenance, or repairs by unqualified personnel may void the manufacturer's warranty. See Chapter 1 of this manual for definitions of qualified personnel.

**NOTICE**

This equipment must be installed in accordance with the appropriate national and local codes of the country and/or region in which the appliance is installed. See **NATIONAL CODE REQUIREMENTS** in Chapter 2 of this manual for specifics.

**NOTICE TO U.S. CUSTOMERS**

This equipment is to be installed in compliance with the basic plumbing code of the Building Officials and Code Administrators International, Inc. (BOCA) and the Food Service Sanitation Manual of the U.S. Food and Drug Administration.

**NOTICE**

Drawings and photos used in this manual are intended to illustrate operational, cleaning and technical procedures and may not conform to onsite management operational procedures.

**NOTICE TO OWNERS OF UNITS EQUIPPED WITH COMPUTERS**

**U.S.**

This device complies with Part 15 of the FCC rules. Operation is subject to the following two conditions: 1) This device may not cause harmful interference, and 2) This device must accept any interference received, including interference that may cause undesired operation. While this device is a verified Class A device, it has been shown to meet the Class B limits.

**CANADA**

This digital apparatus does not exceed the Class A or B limits for radio noise emissions as set out by the ICES-003 standard of the Canadian Department of Communications.

Cet appareil numérique n'émet pas de bruits radioélectriques dépassant les limites de classe A et B prescrites dans la norme NMB-003 édictée par le Ministre des Communications du Canada.

**⚠ DANGER**

Improper installation, adjustment, maintenance or service, and unauthorized alterations or modifications can cause property damage, injury, or death. Read the installation, operating, and service instructions thoroughly before installing or servicing this equipment.

**⚠ DANGER**

The front ledge of this appliance is not a step! Do not stand on the appliance. Serious injury can result from slips or contact with the hot oil.

**⚠ DANGER**

Do not store or use gasoline or other flammable liquids or vapors in the vicinity of this or any other appliance.

**⚠ DANGER**

The crumb tray in fryers equipped with a filter system must be emptied into a fireproof container at the end of frying operations each day. Some food particles can spontaneously combust if left soaking in certain shortening material.

**⚠ WARNING**

Do not bang fry baskets or other utensils on the fryer's joiner strip. The strip is present to seal the joint between the fry vessels. Banging fry baskets on the strip to dislodge shortening will distort the strip, adversely affecting its fit. It is designed for a tight fit and should only be removed for cleaning.

**⚠ DANGER**

Adequate means must be provided to limit the movement of this appliance without depending on or transmitting stress to the electrical conduit. A restraint kit is provided with the fryer. If the restraint kit is missing contact your local Frymaster Factory Authorized Servicer (FAS) for part number 826-0900.

**⚠ DANGER**

This fryer has two power cords and prior to movement, testing, maintenance and any repair on your Frymaster fryer; disconnect BOTH electrical power cords from the electrical power supply.

## **WARRANTY STATEMENT**

Frymaster, L.L.C. makes the following limited warranties to the original purchaser only for this equipment and replacement parts:

### ***A. WARRANTY PROVISIONS - FRYERS***

1. Frymaster L.L.C. warrants all components against defects in material and workmanship for a period of one year.
2. All parts, with the exception of the frypot, heating elements and fuses, are warranted for one year after installation date of fryer.
3. If any parts, except fuses, become defective during the first year after installation date, Frymaster will also pay straight-time labor costs to replace the part, plus up to 100 miles/160 km of travel (50 miles/80 km each way).

### ***B. WARRANTY PROVISIONS - FRYPOTS***

(Applies to fryers manufactured after December 1, 2003, only.)

If a frypot develops a leak within ten years after installation, Frymaster will, at its option, either replace the entire battery or replace the frypot, allowing up to the maximum time per the Frymaster time allowance chart hours of straight-time labor plus up to 100 miles/160 km of travel (50 miles/80 km each way) to change the frypot.

### ***C. WARRANTY PROVISIONS - HEATING ELEMENTS***

1. Frymaster L.L.C. warrants the heating elements against defective material or workmanship for a period of three years from the original installation date, parts only.
2. This warranty does not cover ancillary components, including the high-limit, temperature probe, and contactors.

### ***D. WARRANTY PROVISIONS - COOKING COMPUTER***

1. Frymaster L.L.C. warrants the M-2000 Cooking Computer against defective material or workmanship for a period of one year from the original installation date, parts and labor. Replacements for defective units during the second year include part only. Labor is charged to the store during the second and third years. The third year, warranty will cover the part at a reduced cost of \$90.00.
2. During this warranty period, Frymaster will, at its option, repair or replace defective cooking computer returned with new or factory rebuilt and functionally operative units.
3. For replacement of defective computers under warranty, call your local Frymaster Factory Authorized Servicer. All computers replaced under the Frymaster exchange program only carry the remaining original warranty.

## ***E. PARTS RETURN***

All defective in-warranty parts must be returned to a Frymaster Authorized Factory Servicer within 60 days for credit. After 60 days, no credit will be allowed.

## ***F. WARRANTY EXCLUSIONS***

This warranty does not cover equipment that has been damaged due to misuse, abuse, alteration, or accident such as:

- improper or unauthorized repair (including any frypot which is welded in the field);
- failure to follow proper installation instructions and/or scheduled maintenance procedures as prescribed in your MRC cards. Proof of scheduled maintenance is required to maintain the warranty;
- improper maintenance;
- damage in shipment;
- abnormal use;
- removal, alteration, or obliteration of either the rating plate or the date code on the heating elements;
- operating the frypot without shortening or other liquid in the frypot;
- no fryer will be warranted under the seven-year program for which a proper start-up form has not been received.

This warranty also does not cover:

- transportation or travel over 100 miles/160 km (50 miles/80 km each way), or travel over two hours;
- overtime or holiday charges;
- consequential damages (the cost of repairing or replacing other property which is damaged), loss of time, profits, use or any other incidental damages of any kind.

There are no implied warranties of merchantability or fitness for any particular use or purpose.

This warranty is applicable at the time of this printing and is subject to change.

# BIRE14/MRE14 SERIES ELECTRIC FRYER

## CHAPTER 1: INTRODUCTION

---

### 1.1 General

Read the instructions in this manual thoroughly before attempting to operate this equipment. This manual covers all configurations of McDonald's RE14 models. The fryers in this model family have most parts in common, and when discussed as a group, will be referred to as "RE14" fryers.

Although similar in appearance to the PH14 McDonald's electric fryers, the RE14 fryers feature a significantly different rotating element with an enhanced design. The Euro-Look design incorporates a rounded topcap and a large round drain, which ensures that fries and other debris, will be washed into the filter pan. Other features, including the deep cold-zones and easy to clean, open frypots remain essentially unchanged. The RE14 fryers are controlled with the M2000 computer. Fryers in this series come in full- or split-vat arrangements, and can be purchased as single units or in batteries of up to five fryers.

### 1.2 Safety Information

Before attempting to operate your unit, read the instructions in this manual thoroughly.

Throughout this manual, you will find notations enclosed in double-bordered boxes similar to the one below.

 **DANGER**

**Hot oil causes severe burns. Never attempt to move a fryer containing hot oil or to transfer hot oil from one container to another.**

 **CAUTION** boxes contain information about actions or conditions that *may cause or result in a malfunction of your system*.

 **WARNING** boxes contain information about actions or conditions that *may cause or result in damage to your system*, and which may cause your system to malfunction.

 **DANGER** boxes contain information about actions or conditions that *may cause or result in injury to personnel*, and which may cause damage to your system and/or cause your system to malfunction.

**Fryers in this series are equipped with the following automatic safety features:**

1. Two high-temperature detection features shut off power to the elements should the temperature controls fail.
2. A safety switch built into the drain valve prevents the elements from heating with the drain valve even partially open.

### 1.3 Computer Information for the M2000 Computers

This equipment has been tested and found to comply with the limits for a Class A digital device, pursuant to Part 15 of the FCC rules. While this device is a verified Class A device, it has been shown to meet the Class B limits. These limits are designed to provide reasonable protection against harmful interference when the equipment is operated in a commercial environment. This equipment generates, uses and can radiate radio frequency energy and, if not installed and used in accordance with the instruction manual, may cause harmful interference to radio communications. Operation of the equipment in a residential area is likely to cause harmful interference in which case the user will be required to correct the interference at their own expense.

The user is cautioned that any changes or modifications not expressly approved by the party responsible for compliance could void the user's authority to operate the equipment.

If necessary, the user should consult the dealer or an experienced radio and television technician for additional suggestions.

The user may find the following booklet prepared by the Federal Communications Commission helpful: "How to Identify and Resolve Radio-TV Interference Problems". This booklet is available from the U.S. Government Printing Office, Washington, DC 20402, Stock No. 004-000-00345-4.

### 1.4 European Community (CE) Specific Information

The European Community (CE) has established certain specific standards regarding equipment of this type. Whenever a difference exists between CE and non-CE standards, the information or instructions concerned are identified by means of shadowed boxes similar to the one below.

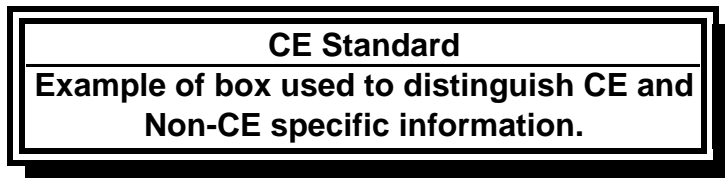

### 1.5 Installation, Operating, and Service Personnel

Operating information for Frymaster equipment has been prepared for use by qualified and/or authorized personnel only, as defined in Section 1.6. **All installation and service on Frymaster equipment must be performed by qualified, certified, licensed, and/or authorized installation or service personnel, as defined in Section 1.6.**

### 1.6 Definitions

#### **QUALIFIED AND/OR AUTHORIZED OPERATING PERSONNEL**

Qualified/authorized operating personnel are those who have carefully read the information in this manual and have familiarized themselves with the equipment functions, or who have had previous experience with the operation of the equipment covered in this manual.

## QUALIFIED INSTALLATION PERSONNEL

Qualified installation personnel are individuals, firms, corporations, and/or companies which, either in person or through a representative, are engaged in and are responsible for the installation of electrical appliances. Qualified personnel must be experienced in such work, be familiar with all electrical precautions involved, and have complied with all requirements of applicable national and local codes.

## QUALIFIED SERVICE PERSONNEL

Qualified service personnel are those who are familiar with Frymaster equipment and who have been authorized by Frymaster, L.L.C. to perform service on the equipment. All authorized service personnel are required to be equipped with a complete set of service and parts manuals, and to stock a minimum amount of parts for Frymaster equipment. A list of Frymaster Factory Authorized Servicers (FAS's) is located on the Frymaster website at [www.frymaster.com](http://www.frymaster.com). *Failure to use qualified service personnel will void the Frymaster warranty on your equipment*

### 1.7 Shipping Damage Claim Procedure

#### ***What to do if your equipment arrives damaged:***

Please note that this equipment was carefully inspected and packed by skilled personnel before leaving the factory. The freight company assumes full responsibility for safe delivery upon acceptance of the equipment.

1. **File Claim for Damages Immediately** - regardless of extent of damage.
2. **Inspect For and Record All Visible Loss or Damage**, and ensure that this information is noted on the freight bill or express receipt and is signed by the person making the delivery.
3. **Concealed Loss or Damage**- If damage is unnoticed until equipment is unpacked, notify the freight company or carrier **immediately** upon discovery and file a concealed damage claim. This must be submitted within 15 days of date of delivery. Be sure to retain container for inspection.

***Frymaster* DOES NOT ASSUME RESPONSIBILITY FOR DAMAGE OR LOSS  
INCURRED IN TRANSIT.**



## 1.8 Service Information

For non-routine maintenance or repairs, or for service information, contact your local Frymaster Authorized Servicer (FAS). In order to assist you quickly, the Frymaster Factory Authorized Servicer (FAS) or Service Department representative requires certain information about your equipment. Most of this information is printed on a data plate affixed to the inside of the fryer door. Part numbers are found in the Installation, Operation, Service, and Parts Manual. Parts orders may be placed directly with your local FAS or distributor. A list of Frymaster Factory Authorized Servicers (FAS's) is located on the Frymaster website at [www.frymaster.com](http://www.frymaster.com). If you do not have access to this list, contact the Frymaster Service Department at 1-800-551-8633 or 1-318-865-1711 or by email at [service@frymaster.com](mailto:service@frymaster.com).

The following information will be needed in order to assist you efficiently:

Model Number \_\_\_\_\_

Serial Number \_\_\_\_\_

Voltage \_\_\_\_\_

Nature of the Problem \_\_\_\_\_

\_\_\_\_\_

\_\_\_\_\_

**RETAIN AND STORE THIS MANUAL IN A SAFE PLACE FOR FUTURE USE.**

# BIRE14/MRE14 SERIES ELECTRIC FRYER

## CHAPTER 2: INSTALLATION INSTRUCTIONS

---

### 2.1 General Installation Requirements

Proper installation is essential for the safe, efficient, trouble-free operation of this appliance.

Qualified, licensed, and/or authorized installation or service personnel, as defined in Section 1.6 of this manual, should perform all installation and service on Frymaster equipment.

**Failure to use qualified, licensed, and/or authorized installation or service personnel (as defined in Section 1.6 of this manual) to install or otherwise service this equipment will void the Frymaster warranty and may result in damage to the equipment or injury to personnel.**

Where conflicts exist between instructions and information in this manual and local or national codes or regulations, installation and operation shall comply with the codes or regulations in force in the country in which the equipment is installed.

Service may be obtained by contacting your local Factory Authorized Servicer.

#### NOTICE

All fryers shipped without factory supplied cords and plug assemblies must be hardwired using flexible conduit to the terminal block located on the rear of the fryer. These fryers should be wired to NEC specifications. Hardwired units must include installation of restraint devices.

#### DANGER

Adequate means must be provided to limit the movement of this appliance without depending on or transmitting stress to the electrical conduit. A restraint kit is provided with the fryer. If the restraint kit is missing contact your local Frymaster Factory Authorized Servicer (FAS) for part number 826-0900.

#### NOTICE

If this equipment is wired directly into the electrical power supply, a means for disconnection from the supply having a contact separation of at least 3-mm in all poles must be incorporated in the fixed wiring.

#### NOTICE

This equipment must be positioned so that the plug is accessible unless other means for disconnection from the power supply (e.g., a circuit breaker) is provided.

#### NOTICE

If this appliance is permanently connected to fixed wiring, it must be connected by means of copper wires having a temperature rating of not less than 167°F (75°C).

### **NOTICE**

If the electrical power supply cord is damaged, it must be replaced by a Frymaster Dean Factory Authorized Servicer technician or a similarly qualified person in order to avoid a hazard.

### **DANGER**

This appliance must be connected to a power supply having the same voltage and phase as specified on the rating plate located on the inside of the appliance door.

### **DANGER**

All wiring connections for this appliance must be made in accordance with the wiring diagram(s) furnished with the appliance. Refer to the wiring diagram(s) affixed to the inside of the appliance door when installing or servicing this equipment.

### **DANGER**

Frymaster appliances equipped with legs are for stationary installations. Appliances fitted with legs must be lifted during movement to avoid damage to the appliance and bodily injury. For movable installations, optional equipment casters must be used. Questions? Call 1-800-551-8633.

### **DANGER**

Do not attach an apron drainboard to a single fryer. The fryer may become unstable, tip over, and cause injury. The appliance area must be kept free and clear of combustible material at all times.

### **DANGER**

Building codes prohibit a fryer with its open tank of hot oil being installed beside an open flame of any type, including those of broilers and ranges.

In the event of a power failure, the fryer(s) will automatically shut down. If this occurs, turn the power switch OFF. Do not attempt to start the fryer(s) until power is restored.

This appliance must be kept free and clear of combustible material, except that it may be installed on combustible floors.

A clearance of 6 inches (15cm) must be provided at both sides and back adjacent to combustible construction. A minimum of 24 inches (61cm) should be provided at the front of the equipment for servicing and proper operation.

### **WARNING**

**Do not block the area around the base or under the fryers.**

## **2.1.2 Electrical Grounding Requirements**

All electrically operated appliances must be grounded in accordance with all applicable national and local codes, and, where applicable, CE codes. All units (cord connected or permanently connected) should be connected to a grounded power supply system. A wiring diagram is located on the inside of the fryer door. Refer to the rating plate on the inside of the fryer door for proper voltages.

**⚠ WARNING**

To ensure the safe and efficient operation of the fryer and hood, the electrical plug for the 120-volt line, which powers the hood, must be fully engaged and locked in its pin and sleeve socket.

### 2.1.3 Australian Requirements

To be installed in accordance with AS 5601 / AG 601, local authority, gas, electricity, and any other relevant statutory regulations.

## 2.2 Power Requirements

The three phase supply plug for the elements is rated at 60 amps, 250 VAC and is NEMA configuration L15-60P. The control and filter plug is rated at 20 amps, 120/208 VAC and is NEMA configuration L21-20P. Each fryer should have its cord for the element supply on an individual circuit as well as the control cord.

VOLTAGE	PHASE	WIRE SERVICE	MIN. SIZE	AWG (mm <sup>2</sup> )	AMPS PER LEG		
					L1	L2	L3
208	3	3	6	(16)	39	39	39
240	3	3	6	(16)	34	34	34
480	3	3	8	(10)	17	17	17
220/380	3	4	6	(16)	21	21	21
240/415	3	4	6	(16)	20	20	21
230/400	3	4	6	(16)	21	21	21
230/400 France Only	3	4	6	(16)	25	25	25

**NOTICE**

If this appliance is permanently connected to fixed wiring, it must be connected by means of copper wires having a temperature rating of not less than 167°F (75°C).

**⚠ DANGER**

This appliance must be connected to a power supply having the same voltage and phase as specified on the rating plate located on the inside of the appliance door.

**⚠ DANGER**

All wiring connections for this appliance must be made in accordance with the wiring diagram(s) furnished with the appliance. Refer to the wiring diagram(s) affixed to the inside of the appliance door when installing or servicing this equipment.

### 2.3 After Fryers Are Positioned At the Frying Station

**⚠ DANGER**

No structural material on the fryer should be altered or removed to accommodate placement of the fryer under a hood. Questions? Call the Frymaster Dean Service Hotline at 1-800-551-8633.

1. Once the fryer has been positioned at the frying station, use a carpenter's level placed across the top of the frypot to verify that the unit is level, both side-to-side and front-to-back.

To level fryers, adjust the casters being careful to ensure the fryer(s) are at the proper height in the frying station.

When the fryer is leveled in its final position, install the restraints provided with the unit to limit its movement so that it does not depend on or transmit stress to the electrical conduit or connection. Install the restraints in accordance with the provided instructions (see illustration below). If the restraints are disconnected for service or other reasons, they must be reconnected before the fryer is used.

**⚠ DANGER**

**Adequate means must be provided to limit the movement of this appliance without depending on or transmitting stress to the electrical conduit. A restraint kit is provided with the fryer. If the restraint kit is missing contact your local Frymaster Factory Authorized Servicer (FAS) for part number 826-0900.**

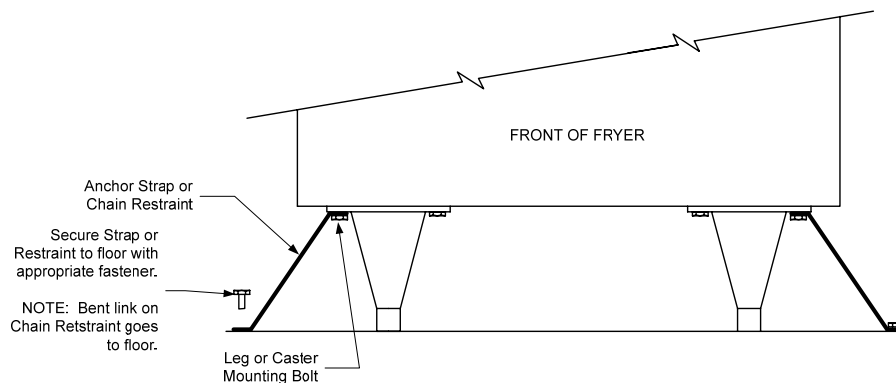

**⚠ DANGER**

**Hot oil can cause severe burns. Avoid contact. Under all circumstances, oil must be removed from the fryer before attempting to move it to avoid spills, falls, and severe burns. Fryers may tip and cause personal injury if not secured in a stationary position.**

2. Close fryer drain-valve(s) and fill frypot with water to the bottom oil level line.
3. Boil out frypot(s) in accordance with the instructions in Section 5.1.4 of this manual.
4. Drain, clean, and fill frypot(s) with cooking oil. (See *Equipment Setup and Shutdown Procedures* in Chapter 3.)

# BIRE14/MRE14 SERIES ELECTRIC FRYER

## CHAPTER 3: OPERATING INSTRUCTIONS

---

### FINDING YOUR WAY AROUND THE BIRE14 SERIES ELECTRIC FRYER

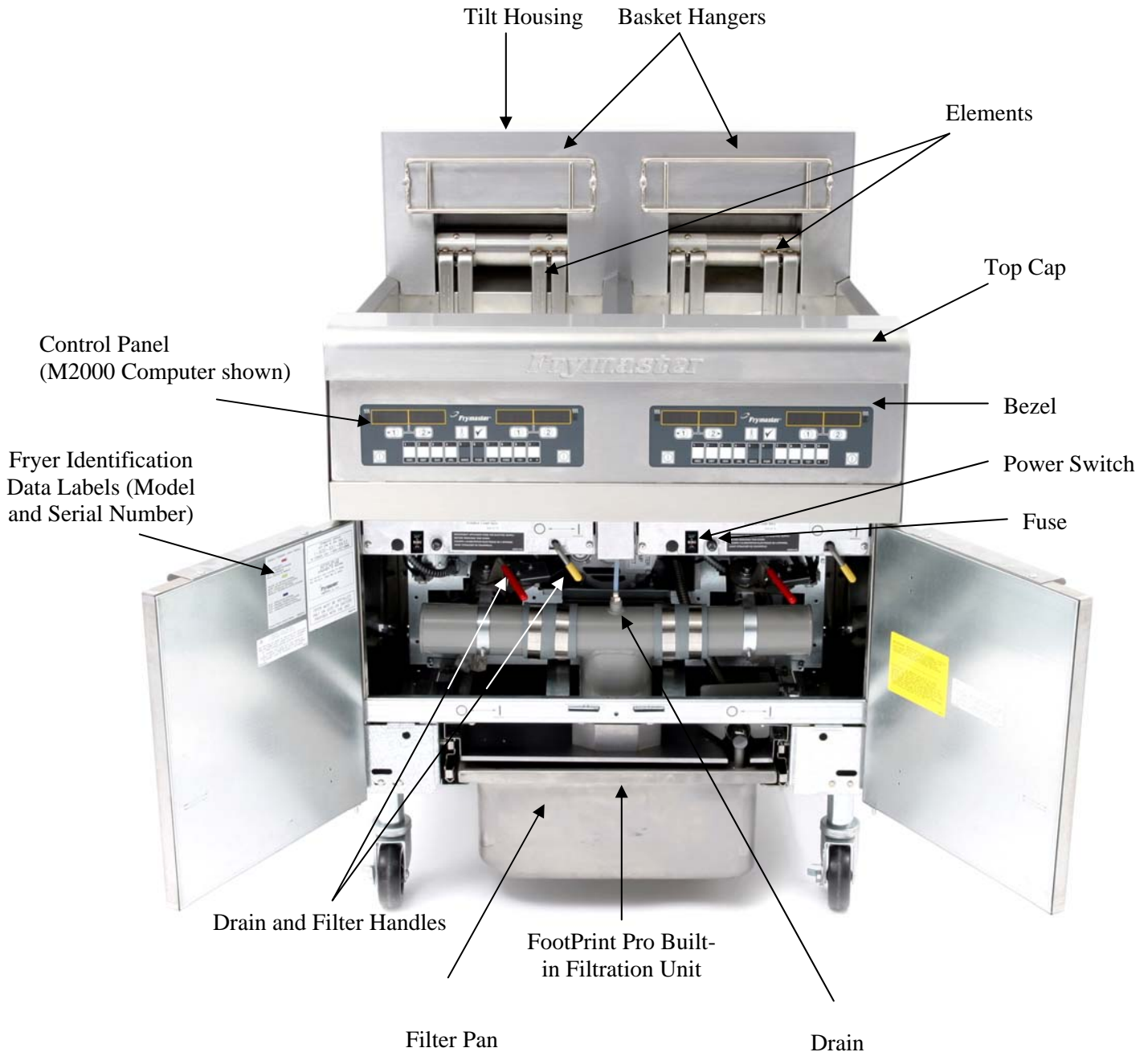

**TYPICAL CONFIGURATION (BIRE214 SHOWN) Domestic**  
**NOTE:** The appearance of your fryer may differ slightly from that shown depending upon the configuration and date of manufacture.

### 3.1 Equipment Setup and Shutdown Procedures

#### Setup

**⚠ DANGER**

Never operate the appliance with an empty frypot. The frypot must be filled to the fill line with water or oil before energizing the elements. Failure to do so will result in irreparable damage to the elements and may cause a fire.

**⚠ DANGER**

Remove all drops of water from the frypot before filling with oil. Failure to do so will cause spattering of hot liquid when the oil is heated to cooking temperature.

1. Fill the frypot with cooking oil to the bottom OIL LEVEL line located on the rear of the frypot. This will allow for oil expansion as heat is applied. Do not fill cold oil any higher than the bottom line; overflow may occur as heat expands the oil.
2. Ensure that the power cord(s) is/are plugged into the appropriate receptacle(s). Verify that the face of the plug is flush with the outlet plate, with no portion of the prongs visible.
3. Ensure that the power is switched on. Some models are equipped with a master switch located behind the fryer door cabinet on the front panel of the component box, next to the fuse. See page 3-1. **STANDBY** or **OFF** is displayed on the computer.
4. Ensure that the computer is switched ON.
5. Ensure that the oil level is at the top OIL LEVEL line when the oil *is at its cooking temperature*. It may be necessary to add oil to bring the level up to the proper mark, after it has reached cooking temperature.

#### Shutdown

1. Turn the fryer off or STANDBY.
2. Filter the oil and clean the fryers (See Chapters 4 and 5).
3. Place the frypot covers on the frypots.

### 3.2 Operation

*If this is the first time the fryer is being used, refer to the frypot boil-out procedure on Page 5-2.*

This fryer is equipped with M2000 computers (illustrated below). Refer to the separate *M2000 Computer Operating Instructions* furnished with the fryer for the computer programming and operating procedures.



**M2000 COMPUTER**

Refer to Chapter 4 of this manual for operating instructions for the built-in filtration system.

# BIRE14/MRE14 SERIES ELECTRIC FRYER

## CHAPTER 4: FILTRATION INSTRUCTIONS

### 4.1 Introduction

The FootPrint Pro filtration system allows the oil in one frypot to be safely and efficiently filtered while the other frypots in a battery remain in operation.

Section 4.2 covers preparation of the filter system for use. Operation of the system is covered in section 4.3.

### **⚠ WARNING**

**The on-site supervisor is responsible for ensuring that operators are made aware of the inherent hazards of operating a hot oil filtering system, particularly the aspects of oil filtration, draining and cleaning procedures.**

### 4.2 Preparing the Filter for Use

1. Pull the filter pan out from the cabinet and remove the crumb tray, hold-down ring, filter pad (or paper), and filter screen.

(See Figure 1) Clean all metal parts with a solution of All Purpose Concentrate and hot water then dry thoroughly.

The filter pan is equipped with rollers in rails, much like a kitchen drawer. The pan can be removed from the cabinet for cleaning by lifting the front of the pan to disengage the front rollers, then pulling it forward until the rear rollers clear the rails. The pan cover must not be removed except for cleaning, interior access, or to allow a shortening disposal unit (MSDU) to be positioned under the drain. If using an MSDU built before January 2004 see instructions on page 4-4.

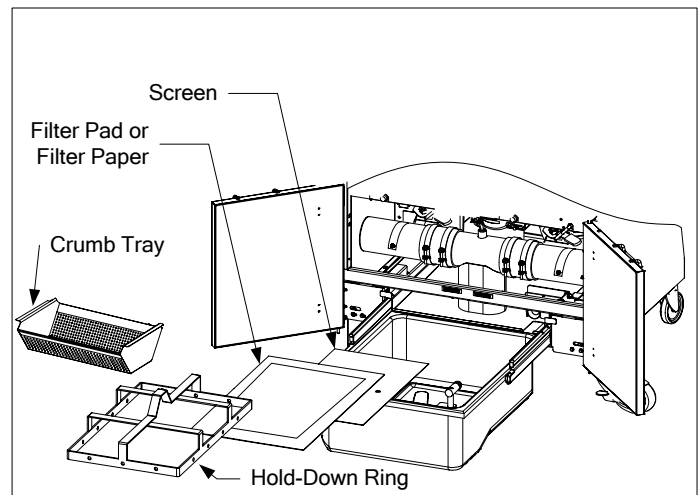

**Figure 1**

2. Inspect the filter pan connection fitting to ensure that both O-rings are in good condition. (See Figure 2)

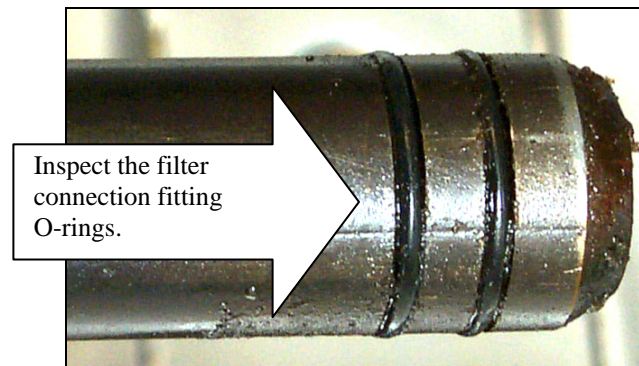

**Figure 2**



- Then in reverse order, place the metal filter screen in the center of the bottom of the pan, then lay a filter pad over the screen, ensuring that the **rough** side of the pad is up. Make sure that the pad is in between the embossed ridges of the filter pan. Then position the hold down ring on top of the pad. If using filter paper, lay a sheet of filter paper over the top of the pan overlapping on all sides. Position the hold down ring over the filter paper and lower the ring into the pan, allowing the paper to fold up and around the ring as it is pushed to the bottom of the pan. Then sprinkle 1 packet (8-ounces) of filter powder over the filter paper.
- Reinstall the crumb tray at the front of the pan. (See Figure 1)

**DO NOT USE FILTER POWDER WITH THE PAD!**

- Push the filter pan back into the fryer, positioning it under the fryer. The filtration system is now ready for use.

### 4.3 Operation of the Filter

**⚠ DANGER**

Draining and filtering of oil must be accomplished with care to avoid the possibility of a serious burn caused by careless handling. The oil to be filtered is at or near 350°F (177°C). Ensure drain handles are in their proper position before operating any switches or valves. Wear all appropriate safety equipment when draining and filtering oil.

**⚠ DANGER**

**NEVER** attempt to drain oil from the fryer with the elements energized! Doing so will cause irreparable damage to the elements and may cause a flash fire. Doing so will also void the Frymaster warranty.

- Turn the fryer power OFF. Drain the frypot into the filter pan. If necessary, use the *Fryer's Friend* clean-out rod to clear the drain from **inside** the frypot.

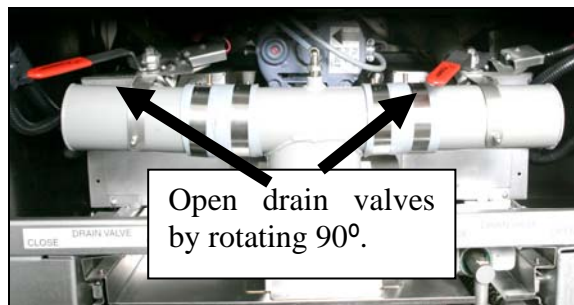

**Open the drain valves on the frypot and drain the oil into the filter pan.**

**⚠ DANGER**

**Do not drain more than one frypot at a time into the built-in filtration unit to avoid overflow and spillage of hot oil.**

**⚠ DANGER**

**NEVER attempt to clear a clogged drain valve from the front of the valve! Hot oil will rush out creating the potential for severe burns.**

**DO NOT hammer on the drain valve with the cleanout rod or other objects. Damage to the ball inside will result in leaks and will void the Frymaster warranty.**

2. After the oil has drained from the frypot, turn the filter handle to the ON position to start the pump and begin the filtering process. There may be a slight delay before the pump activates.



**Turn the filter handle to the ON position.**

3. The filter pump draws the oil through the filter pad/paper and screen and circulates it back up to and through the frypot during a 5-minute process called polishing. Polishing cleans the oil by trapping solid particles in the filter pad.
4. After the oil is filtered (about 5 minutes), close the drain valve and allow the fryer to refill. Let the filter pump run 10 to 12 seconds after the oil begins to bubble in the frypot then turn the filter off.

**⚠ WARNING**

**The filter pump is equipped with a manual reset switch (see photo below) in case the filter motor overheats or an electrical fault occurs. If this switch trips, turn off power to the filter system and allow the pump motor to cool 20 minutes before attempting to reset the switch.**

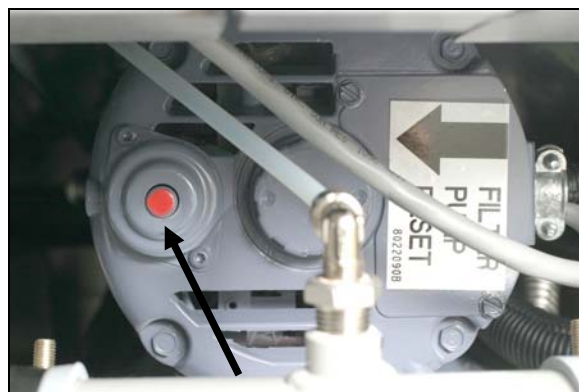

**Filter Pump Reset Switch**

5. Lower the elements into the frypot and reinstall the basket support rack.
6. Ensure the drain valve is fully closed. (If the drain valve is not fully closed, the fryer will not operate.) Turn the fryer ON and allow the oil to reach setpoint.

**⚠ DANGER**

The crumb tray in fryers equipped with a filter system must be emptied into a fireproof container at the end of frying operations each day. Some food particles can spontaneously combust if left soaking in certain shortening material.

**⚠ WARNING**

Do not bang fry baskets or other utensils on the fryer's joiner strip. The strip is present to seal the joint between the fry vessels. Banging fry baskets on the strip to dislodge shortening will distort the strip, adversely affecting its fit. It is designed for a tight fit and should only be removed for cleaning.

#### 4.4 Draining and Disposing of Waste Oil

When your cooking oil has reached the end of its usable life, drain the oil into an appropriate container for transport to the disposal container. Frymaster recommends the use of the McDonald's Shortening Disposal Unit (MSDU). **NOTE:** If using an MSDU built before January 2004 the filter pan cover on must be removed to allow the unit to be positioned beneath the drain. To remove the lid, lift up on the front edge and pull it straight out of the cabinet. Refer to the documentation furnished with your disposal unit for specific operating instructions. If a shortening disposal unit is not available, allow the oil to cool to 100°F (38°C), then drain the oil into a metal stockpot or similar metal container. When draining is finished, close the fryer drain valve securely.

**⚠ DANGER**

Allow oil to cool to 100°F (38°C) before draining into an appropriate container for disposal.

When draining oil into a disposal unit, do not fill above the maximum fill line located on the container.

# BIRE14/MRE14 SERIES ELECTRIC FRYER

## CHAPTER 5: PREVENTATIVE MAINTENANCE

---

### 5.1 Cleaning the Fryer

 **DANGER**

The crumb tray in fryers equipped with a filter system must be emptied into a fireproof container at the end of frying operations each day. Some food particles can spontaneously combust if left soaking in certain shortening material.

 **DANGER**

Never attempt to clean the fryer during the frying process or when the frypot is filled with hot oil. If water comes in contact with oil heated to frying temperature, it will cause spattering of the oil, which can result in severe burns to nearby personnel.

 **WARNING**

Use McDonald's All Purpose Concentrate. Read the directions for use and precautionary statements before use. Particular attention must be paid to the concentration of cleaner and the length of time the cleaner remains on the food-contact surfaces.

#### 5.1.1 Clean Inside and Outside of the Fryer Cabinet – Daily

Clean inside the fryer cabinet with a dry, clean cloth. Wipe all accessible metal surfaces and components to remove accumulated oil and dust.

Clean the outside of the fryer cabinet with a clean, damp cloth soaked with McDonald's All Purpose Concentrate. Wipe with a clean, damp cloth.

#### 5.1.2 Clean the Built-in Filtration System – Daily

 **WARNING**

**Never drain water into the filter pan. Water will damage the filter pump.**

There are no periodic preventive maintenance checks and services required for your FootPrint Pro Filtration System other than daily cleaning of the filter pan and associated components with a solution of hot water and McDonald's All Purpose Concentrate.

#### 5.1.3 Clean Behind Fryers – Weekly

Clean behind fryers in accordance with the procedure detailed in maintenance requirement card (MRC14A).

 **WARNING**

To ensure the safe and efficient operation of the fryer and hood, the electrical plug for the 120-volt line, which powers the hood, must be fully engaged and locked in its pin and sleeve socket.

#### 5.1.4 Clean the Frypot and Heating Elements – Weekly

**⚠ DANGER**

**Never operate the appliance with an empty frypot. The frypot must be filled to the fill line with water or cooking oil before energizing the elements. Failure to do so will result in irreparable damage to the elements and may cause a fire.**

#### Boiling Out the Frypot

Before the fryer is first used, it should be boiled out to ensure that residue from the manufacturing process has been eliminated. Also, after the fryer has been in use for a period of time, a hard film of caramelized cooking oil will form on the inside of the frypot. This film should be periodically removed by following the boil-out procedure contained in maintenance requirement card (MRC14A). *Refer to the separate M2000 Computer Operating Instructions furnished with the fryer for specific details on setting up the computer for boil-out operation.*

#### 5.1.5 Clean Detachable Parts and Accessories – Weekly

Wipe all detachable parts and accessories with a clean, dry cloth. Use a clean cloth saturated with a solution of McDonald's All Purpose Concentrate to remove accumulated carbonized oil on detachable parts and accessories. Rinse the parts and accessories thoroughly with clean water and wipe dry before reinstalling.

### 5.2 Annual/Periodic System Inspection

This appliance should be inspected and adjusted periodically by qualified service personnel as part of a regular kitchen maintenance program.

Frymaster recommends that a Factory Authorized Servicer inspect this appliance at least annually as follows:

#### Fryer

- Inspect the cabinet inside and out, front and rear for excessive oil.
- Verify that the heating element wires are in good condition and that leads have no visible fraying or insulation damage and that they are free of oil.
- Verify that heating elements are in good condition with no carbon/caramelized oil build-up. Inspect the elements for signs of extensive dry-firing.
- Verify that the tilt mechanism is working properly when lifting and lowering elements and that the element wires are not binding and/or chafing.
- Verify the heating-element amp-draw is within the allowed range as indicated on the appliance's rating plate.
- Verify that the temperature and high-limit probes are properly connected, tightened and functioning properly, and that mounting hardware and probe guards are present and properly installed.

- Verify that component box and contactor box components (i.e. computer/controller, relays, interface boards, transformers, contactors, etc.) are in good condition and free from oil and other debris.
- Verify that component box and contactor box wiring connections are tight and that wiring is in good condition.
- Verify that all safety features (i.e. contactor shields, drain safety switches, reset switches, etc.) are present and functioning properly.
- Verify that the frypot is in good condition and free of leaks and that the frypot insulation is in serviceable condition.
- Verify that all wiring harnesses and connections are tight and in good condition.

### **Built-In Filtration System**

- Inspect all oil-return and drain lines for leaks and verify that all connections are tight.
- Inspect the filter pan for leaks and cleanliness. If there is a large accumulation of crumbs in the crumb basket, advise the owner/operator that the crumb basket should be emptied into a fireproof container and cleaned daily.
- Verify that all O-rings and seals are present and in good condition. Replace O-rings and seals if worn or damaged.
- Check filtration system integrity as follows:
  - With the filter pan empty, place each oil return handle, one at a time, in the ON position. Verify that the pump activates and that bubbles appear in the cooking oil.
  - Close all oil return valves (i.e., place all oil return handles in the OFF position). Verify proper functioning of each oil return valve by activating the filter pump using the lever on one of the oil return handle microswitches. No air bubbles should be visible in any frypot.
  - Verify that the filter pan is properly prepared for filtering, then drain a frypot of oil heated to 335°F (168°C) into the filter pan and close the frypot drain valve. Place the oil return handle in the ON position. Allow all cooking oil to return to the frypot, indicated by bubbles in the cooking oil. Return the oil return handle to the OFF position. The frypot should have refilled in no more than 2 minutes and 30 seconds.

# BIRE14/MRE14 SERIES ELECTRIC FRYER

## CHAPTER 6: OPERATOR TROUBLESHOOTING

---

### 6.1 Introduction

This section provides an easy reference guide to some of the common problems that may occur during the operation of this equipment. The troubleshooting guides that follow are intended to help correct, or at least accurately diagnose, problems with this equipment. Although the chapter covers the most common problems reported, you may encounter problems that are not covered. In such instances, the Frymaster Technical Services staff will make every effort to help you identify and resolve the problem.

When troubleshooting a problem, always use a process of elimination starting with the simplest solution and working through to the most complex. Never overlook the obvious – anyone can forget to plug in a cord or fail to close a valve completely. Most importantly, always try to establish a clear idea of why a problem has occurred. Part of any corrective action involves taking steps to ensure that it doesn't happen again. If a controller malfunctions because of a poor connection, check all other connections, too. If a fuse continues to blow, find out why. Always keep in mind that failure of a small component may often be indicative of potential failure or incorrect functioning of a more important component or system.

***Before calling a service agent or the Frymaster HOTLINE (1-800-24-FRYER):***

- **Verify that electrical cords are plugged in and that circuit breakers are on.**
- **Verify that frypot drain valves are fully closed.**
- **Have your fryer's model and serial numbers ready to give to the technician assisting you.**

 **DANGER**

**Hot oil will cause severe burns. Never attempt to move this appliance when filled with hot oil or to transfer hot oil from one container to another.**

 **DANGER**

**This equipment should be unplugged when servicing, except when electrical circuit tests are required. Use extreme care when performing such tests.**

**This appliance may have more than one electrical power supply connection point. Disconnect all power cords before servicing.**

**Inspection, testing, and repair of electrical components should be performed by an authorized service agent only.**

## 6.2 Troubleshooting

### 6.2.1 Computer and Heating Problems

Problem	Probable Causes	Corrective Action
<p><b>No Display on Computer.</b></p>	A. Computer not turned on.	A. Press the ON/Off switch to turn the computer on.
	B. No Power to the fryer.	B. This fryer has two cords: a computer power cord and a main power cord. If the computer cord is not plugged in, the computer will not activate. Verify computer power cord is plugged in and that circuit breaker is not tripped.
	C. Computer has failed.	C. Call FAS.
	D. Damaged computer wiring harness.	D. Call FAS
	E. Power supply component or interface board has failed.	E. If any component in the power supply system (including the transformer and interface board) fail, power will not be supplied to the computer and it will not function. Determining which component has failed is beyond the scope of operator troubleshooting. Call FAS.
<p><b>Fryer does not heat.</b></p>	A. Drain valve is open.	A. A drain safety switch prevents the heating element from being energized if the drain valve is not fully closed. Verify that the drain valve is fully closed.
	B. Computer has failed.	B. Call FAS.
	C. Main power cord not plugged in.	C. This fryer has two cords: a 120V power cord and the main 3-phase power cord. If the 120V power cord is plugged in but the main power cord is not, the computer will appear to work normally, but the fryer will not heat. Verify that both the main power cord and 120V is fully seated in its receptacle, locked into place and that circuit breaker is not tripped.



Problem	Probable Causes	Corrective Action
<b>Continued from previous page.</b>	D. One or more other components have failed.	D. If the circuitry in the fryer control system cannot determine the frypot temperature, the system will not allow the element to be energized or will de-energize the element if it is already energized. If the contactor, element, or associated wiring fails, the element will not energize. Determining which specific component is malfunctioning is beyond the scope of operator troubleshooting. Call FAS.
<b>Fryer does not heat after filtering.</b>	Drain valve is open.	This fryer is equipped with a drain safety switch that prevents the heating element from being energized if the drain valve is not fully closed. Verify that the drain valve is fully closed.
<b>Fryer heats until high-limit trips with heat indicator ON.</b>	Temperature probe or computer has failed.	Call FAS.
<b>Fryer heats until high-limit trips without heat indicator ON.</b>	Contactor or computer has failed	Call FAS.
<b>Fryer stops heating with heat indicator ON.</b>	The high-limit thermostat or contactor has failed.	The fact that the heat indicator is ON indicates that the computer is functioning properly and is calling for heat. The high-limit thermostat functions as a normally closed switch. If the thermostat fails, the "switch" opens and power to the elements is shut off. If the contactor fails to close, no power is supplied to the elements. Determining which component has failed is beyond the scope of operator troubleshooting. Call FAS.

## 6.2.2 Error Messages and Display Problems

Problem	Probable Causes	Corrective Action
<b>M2000 display is in wrong temperature scale (Fahrenheit or Celsius).</b>	Incorrect display option programmed.	M2000 computers may be programmed to display in either Fahrenheit or Celsius. Refer to the separate <i>M2000 Computer Operation Manual</i> for instructions on changing the display.
<b>M2000 display shows HI.</b>	Fryer is 15°F (8°C) above setpoint.	This display will appear only if the fryer is in the <i>non-dedicated</i> mode and the frypot temperature rises 15° (8°C) or more above the programmed setpoint. This indicates a problem with the temperature control circuitry. Turn the fryer off and call FAS.
<b>M2000 display shows HOT.</b>	Frypot temperature is more than 410°F (210°C) or, in CE countries, 395°F (202°C).	This is an indication of a malfunction in the temperature control circuitry, including a failure of the high-limit thermostat. Shut the fryer down immediately and call FAS.
<b>M2000 display shows LOW TEMP.</b>	Frypot temperature is between 180°F (82°C) and 315°F (157°C).	This display is normal when the fryer is first turned on and may appear for a short while if a large batch of frozen product is added to the frypot. If the display never goes out, the fryer is not heating. Shut the fryer down and call FAS.
<b>M2000 display shows PROBE FAILURE.</b>	Problem with the temperature measuring circuitry including the probe.	This indicates a problem within the temperature measuring circuitry that is beyond the scope of operator troubleshooting. Shut the fryer down and call FAS.
<b>M2000 display shows IGNITION FAILURE.</b>	Open drain valve, failed computer, failed interface board, open high-limit thermostat.	This indicates that the fryer is not heating. It is displayed if the fryer loses its ability to heat oil. It is also displayed when the oil temperature is above 450°F (232°C) and the high-limit thermostat has opened, halting the heating of the oil. Verify that the drain valves are fully closed. If this does not correct the problem, call your FAS.
<b>M2000 display shows HI-LIMIT.</b>	Computer in high-limit test mode.	This is displayed only during a test of the high-limit circuit and indicates that the high-limit has opened properly.

<b>Problem</b>	<b>Probable Causes</b>	<b>Corrective Action</b>
<b>M2000 display shows HI 2 BAD.</b>	Computer in high-limit test mode.	This is displayed only during a test of the high-limit circuit and indicates that the high-limit has failed. <b>DO NOT OPERATE THE FRYER!</b> Call FAS.
<b>M2000 display shows PROBE FAILURE with alarm sounding.</b>	Damaged computer wiring harness or connector.	Call FAS
<b>M2000 display shows IGN FAILURE with alarm sounding. Heating indicator is on, but no heat.</b>	Drain valve not fully closed.	Press the ON/OFF switch off, close the drain valve(s) completely, then press the ON/OFF switch on.
<b>M2000 display shows LOW TEMP, heating indicator cycles on and off normally.</b>	A. Failed computer.	A. Call FAS.
	B. Damaged computer wiring harness.	B. Call FAS.
<b>M2000 display shows IGN FAILURE and alarm sounds, but fryer operates normally (false alarm).</b>	Failed computer.	Call FAS.
<b>Computer will not go into program mode or some buttons do not actuate.</b>	Failed computer.	Call FAS.
<b>Heat indicator off upon initial startup. Display shows HI or HOT with alarm sounding.</b>	Failed computer.	Call FAS.

### 6.2.3 Filtration Problems

Problem	Probable Causes	Corrective Action
<p><b>Filter pump won't start.</b></p>	<p>A. Power cord is not plugged in or circuit breaker is tripped.</p>	<p>A. Verify that the power cord is fully plugged in. If so, verify that circuit breaker is not tripped.</p>
	<p>B. Pump motor has overheated causing the thermal overload switch to trip.</p>	<p>B. If the motor is too hot to touch for more than a few seconds, the thermal overload switch has probably tripped. Allow the motor to cool at least 45 minutes then press the Pump Reset Switch.</p>
	<p>C. Blockage in filter pump.</p> <p><b>Test:</b> Close the drain valve and pull the filter pan out from the fryer. Activate the pump. If the pump motor hums for a short time then stops, the probable cause is blockage of the pump itself.</p>	<p>C. Pump blockages are usually caused by sediment buildup in the pump due to improperly sized or installed filter components and failure to use the crumb screen. Call FAS.</p>
<p><b>Filter pump runs but oil does not return to frypot and there is no bubbling oil.</b></p>	<p>Blockage in filter pan suction tube.</p> <p><b>Test:</b> Close the drain valve and pull the filter pan out from the fryer. Activate the pump. If bubbling occurs, there is a blockage in the filter pan suction tube.</p>	<p>The blockage may be caused by sediment buildup or, if solid shortening is used, solidified shortening in the tube. Use a thin, flexible wire to remove the blockage. If the blockage cannot be removed, call FAS.</p>
<p><b>Filter pump runs, but oil return is very slow.</b></p>	<p>A. Improperly installed filter pan components.</p>	<p>A. If using filter paper or pad configuration, verify that filter screen is in bottom of pan with paper or pad on top of screen. Verify if using a pad that the rough side is facing up.</p> <p>Verify that O-rings are present and in good condition on filter pan connection fitting.</p> <p>If using Magnasol filter assembly, verify that O-ring is present and in good condition on filter screen fitting.</p>
<p><i>Continued on following page.</i></p>		

<b>Problem</b>	<b>Probable Causes</b>	<b>Corrective Action</b>
<p><b>Continued from previous page.</b></p>	<p>B. Attempting to filter with oil that is not hot enough.</p>	<p>B. In order to properly filter, the oil should be at or near 350°F (177°C). At temperatures lower than this, the oil becomes too thick to pass through the filter medium easily, resulting in much slower oil return and eventual overheating of the filter pump motor. Make sure oil is at or near frying temperature before draining oil into filter pan.</p>



Frymaster, L.L.C., 8700 Line Avenue, Shreveport, Louisiana 71106

TEL 1-318-865-1711

FAX (Parts) 1-318-688-2200

(Tech Support) 1-318-219-7135

PRINTED IN THE UNITED STATES

SERVICE HOTLINE  
1-800-551-8633

819-6151A  
NOVEMBER 2011